

AXOR

AXOR™

HARDWARE

FOR WINDOWS AND DOORS

KOMFORT LINE **K-3**

SMART LINE **S+**

FIRST TILT **FT**

ELITE **E+**

DOOR LINE **DL**



International company

Modern equipment

Qualified personnel

High quality products and service

ABOUT THE FACTORY

AXOR INDUSTRY is a full-cycle factory #1 in Ukraine and one of the biggest factories of this industry branch in CIS.

The factory is instrumented with the modern hi-tech equipment which allowed us to automate the production process and make it correspond with the European standards.

AXOR INDUSTRY production processes are organized in a way that gives a high level of security both to the personnel and environment. Lean resource consumption forms the basis of the work – for example, smart disposal system and water sanitation.

Our warehouse logistics is based on an address tracking and storage system which helps us to make order consolidation fast and accurate.

We provide quality control at every stage of production starting with evaluation of the raw supply materials' quality and making the final tests for the ready products. Quality control procedures are conducted by our own certified laboratory as well as by the independent international institutions.





FULL PRODUCTION CYCLE

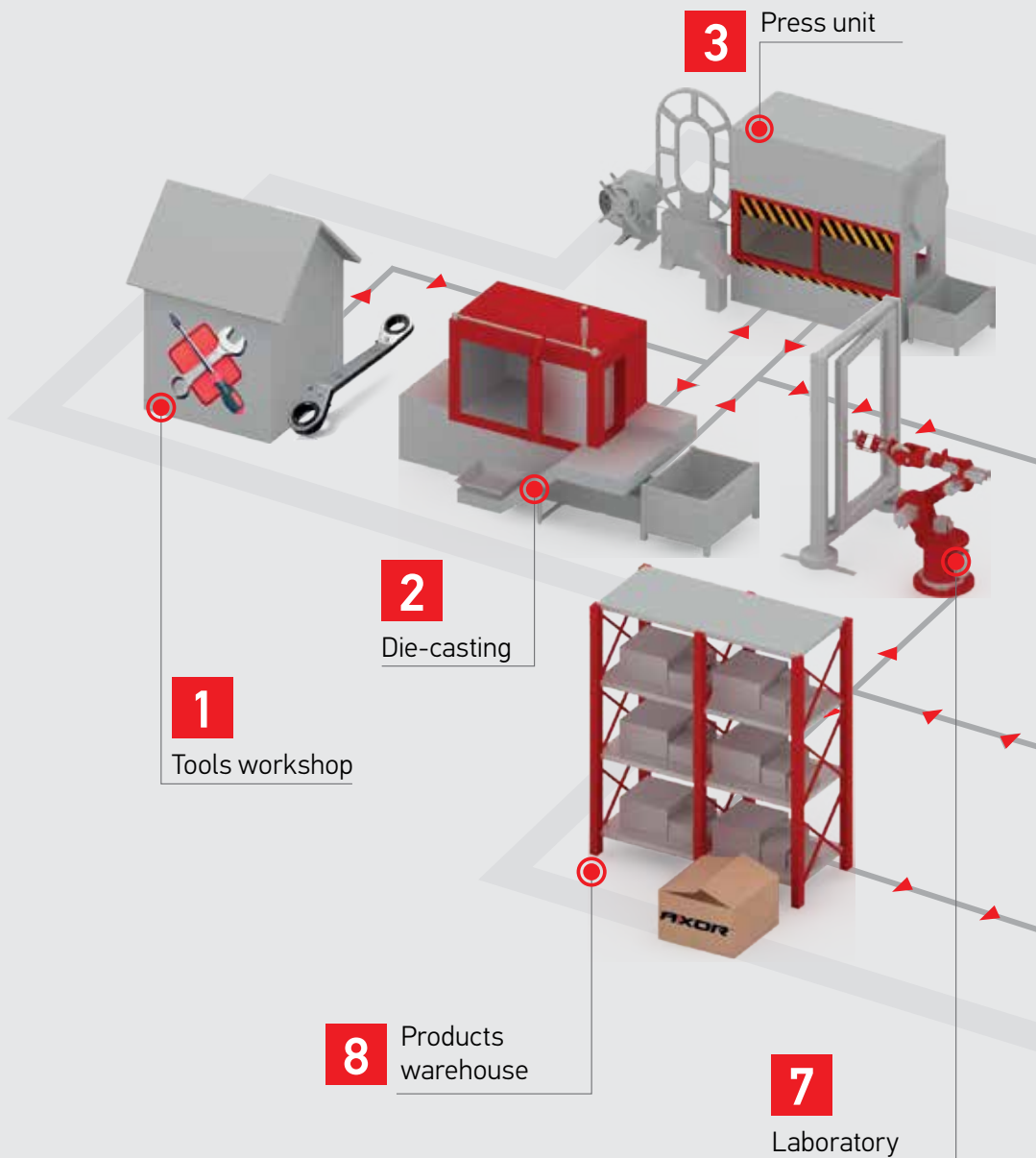

Automation of production processes
Quality's control on each stage
Environment oriented manufacturing

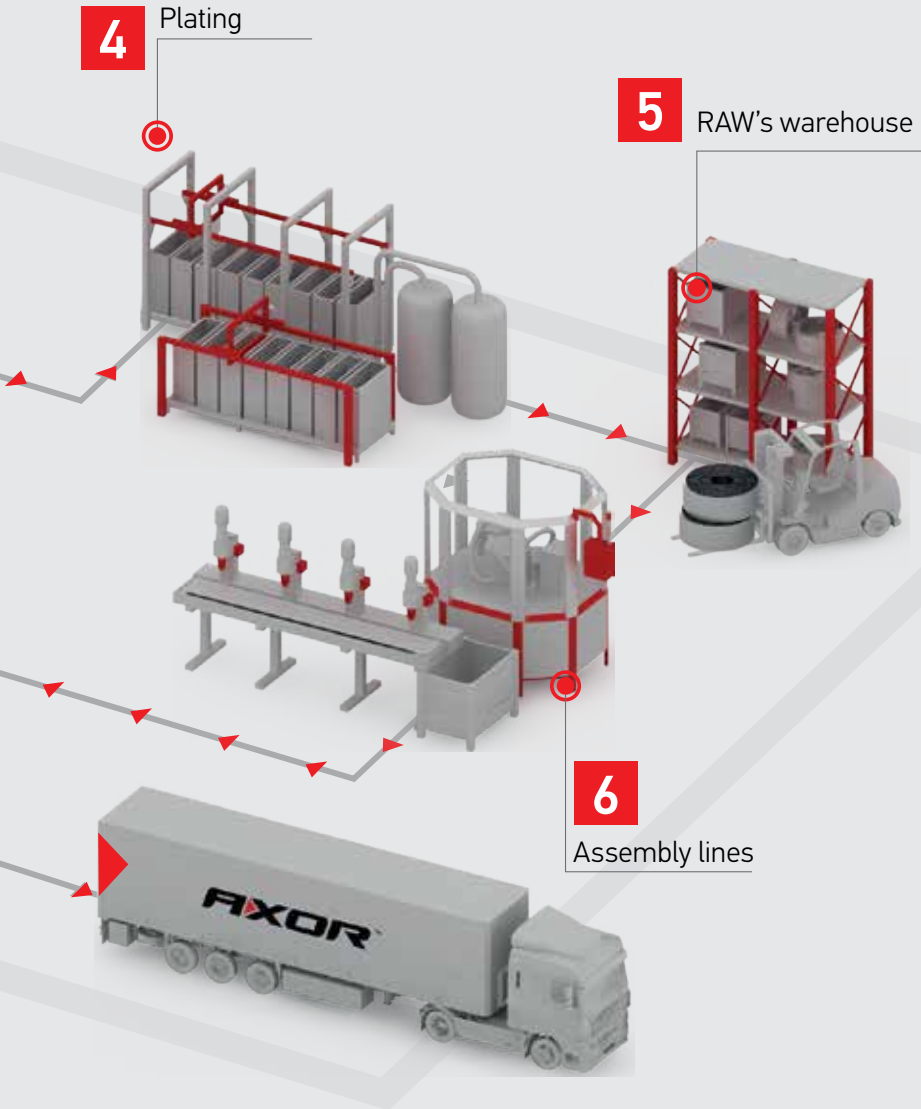

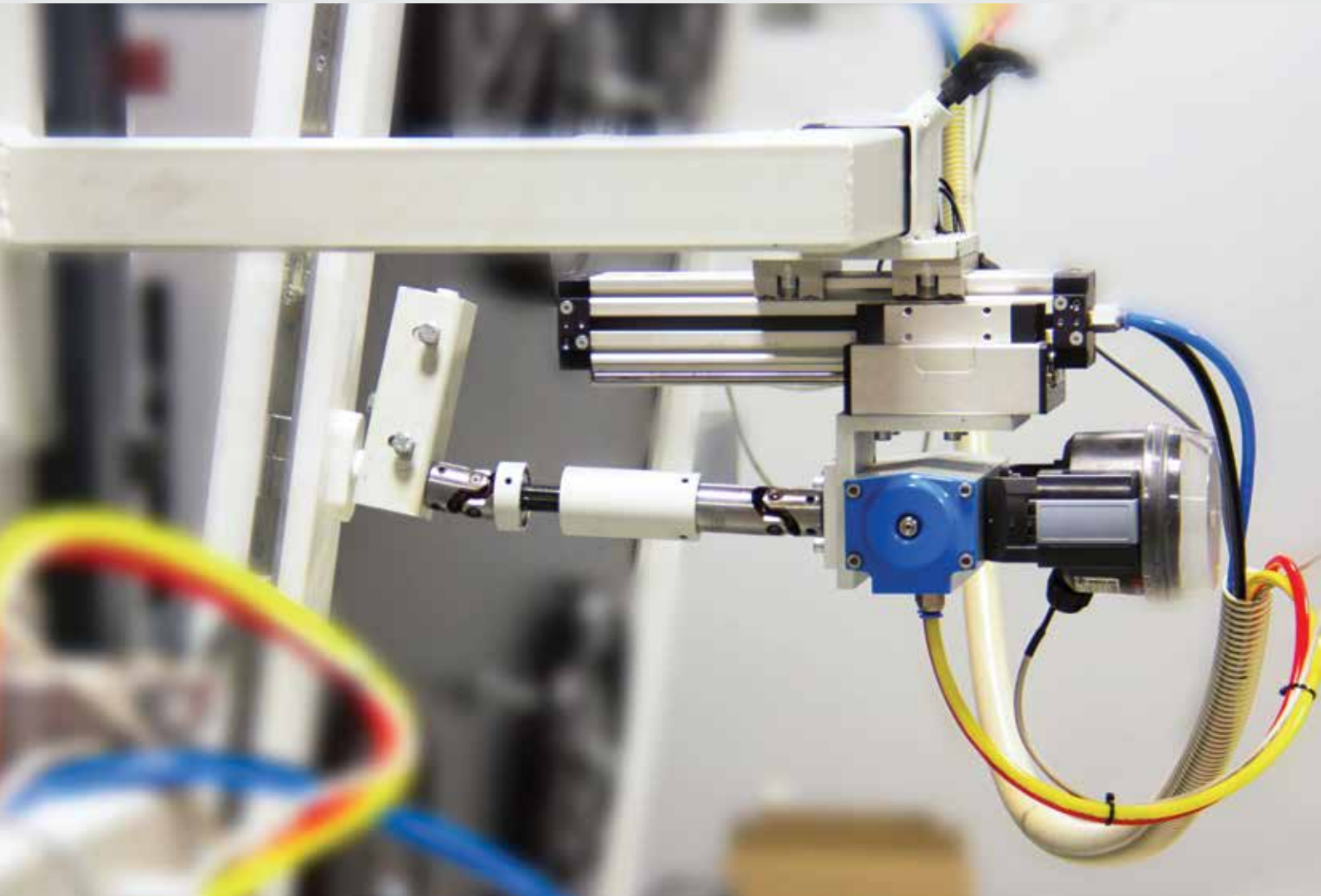

Certified laboratory

Performance test for the number of the opening cycles
Hinge group test for the sustainability with the extra loads
Tests of the hardware security coating

QUALITY CONTROL

Consistent high quality of the products is a matter of principle for us. To provide for the hardware quality control there is a non-stop round the clock certified and modernly equipped laboratory working at the territory of AXOR INDUSTRY factory. Here we can conduct the full cycle of all the necessary hardware tests according to the DSTU B. V. 2.6 – 39:2008, GOST 3077-2001, GOST 538-2001, EN13126-8: performance test for the number for the opening cycles, hinge group test for the sustainability with the extra loads and resistance to corrosion.



According to tests, AXOR INDUSTRY hardware can provide more than 20,000 tilt and turn and more than 10,000 turn cycles of window opening, which is equal to 15 years of normal usage of window construction. We control the quality of the product using its unique code.

TM AXOR hardware fully satisfies the requirements of DSTU, GOST and European norms, which guarantees to the consumers hardware reliability and functional operability during the use of the ready product.

Protective coating

According to the results of the tests conducted by the independent laboratory the hardware coating by TM AXOR was assigned a 5th grade of corrosion resistance (the top-grade according to EN requirements)*.

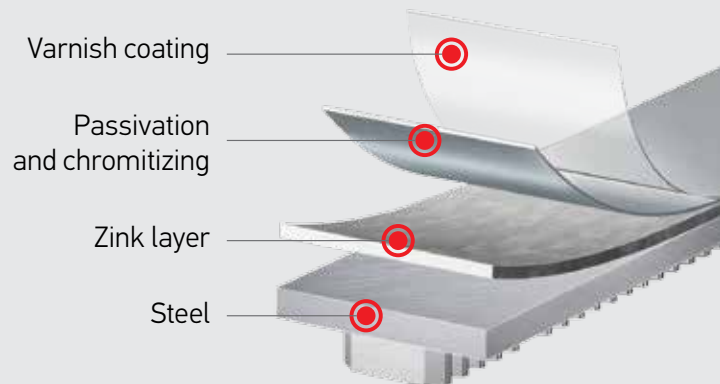

*Salt spray test, $t=40$ degrees, test duration = 480 hours

KOMFORT LINE **K-3**

Reliability. Accessibility. Comfort.

- Komfort Line K-3 – is the standard-class hardware which is designed for the PVC, timber and aluminum windows and doors of the inward opening.
- Komfort Line K-3 has high operational qualities and is equipped with all required extra options, is reliable and functional staying within the range of the attractive prices of its class.
- A window with K-3 hardware can be equipped with several burglar retardant elements.
- Reinforced hinge group allows using the system with the sash weight up to 130 kg.
- Due to the peculiarities of the coating it is perfectly suitable for the use in the regions with high humidity.

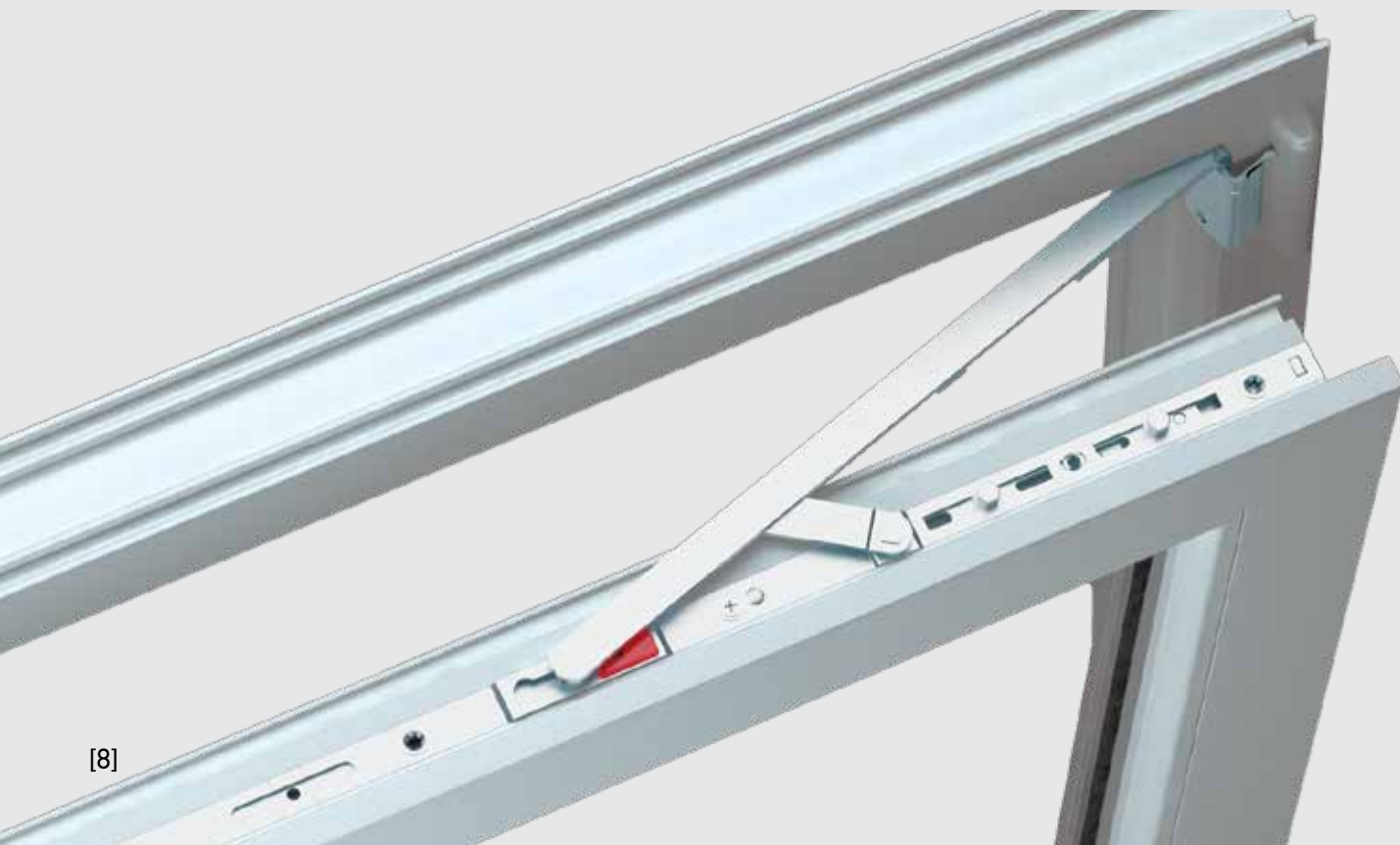

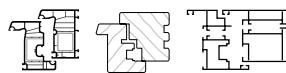

Application range

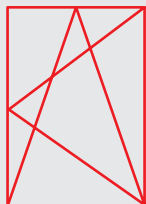

Width: 300–1520 mm
Height: 370–2390 mm

Tilt & turn sash

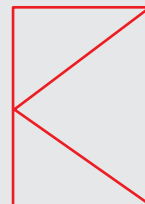

Width: 280–1280 mm
Height: 450–2390 mm

Turn sash

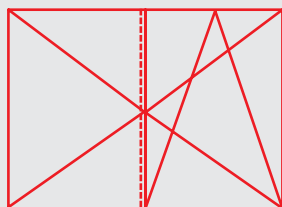

Width: 400–1280 mm
Height: 550–2390 mm

Double sash with the main
tilt & turn sash

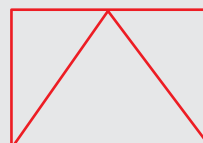

Width: 450–2000 mm
Height: 280–1600 mm

Tilt sash

Security

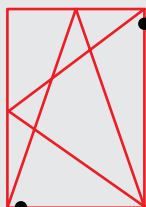

Basic
security



130 kg

Maximum
sash weight

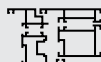

80 kg

Maximum
sash weight

Reliability



Certified
reliability



High
reliability



Additional
functions



Smooth
operation



Tight fitting



Silent
operation

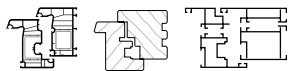

- 1** Anti-theft elements
- 2** Step-by-step opening
- 3** Stay arm
- 4** Wrong operation safety device
- 5** Sash lifter
- 6** Child security lock



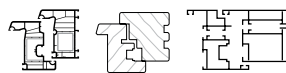

COMFORT AND FUNCTIONALITY

Anti-theft elements



Makes it difficult for the burglars to open the window.

Wrong operation safety device



Provides for the comfortable window closing and blocks false opening.

Step-by-step opening



Allows opening the window in a desired position to create ventilation with a fixed gap from 12 to 20mm.

Sash lifter



Excludes sash drooping in the "closed" mode.

Stay arm



Allows for the comfortable closing of the window due to the sash latch mechanism. Include blocking of the false handle turning in tilt mode.

Child security lock



Allows preventing window opening by the little children.

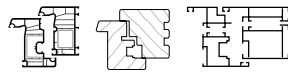

TECHNICAL FEATURES

Lock pins in the hardware housing



Lock pins in the hardware housing that allow fixing all the hardware elements before the self-tapping screws are engaged and thus exclude elements' shifting during the process.

Bush of the bottom hinge



The bottom hinge has a bush with the position lock pin made of the high endurance polymer. It prevents the adjustment screw from the unscrewing during the opening of the sash.

Mounting holes



Mounting holes in the top and bottom hinge bearings are designed in a way that all self-tapping screws would get inside the frame reinforcement.

Wrong operation safety device



Lock up in a central position before the mounting. Works for the clearance of 10,5–14 mm. In the case of necessity the frame section can be regulated in height for ± 1 cm.

Drive pins



With the lengths of 5 mm and diameter of 3 mm drive pins provide for the reliable lock up of the bottom hinge before the mounting start (screwing).

Stay arm hinge



It is cross-functional – for both left-hand and right-hand opening. Hold down adjustment is ± 1 mm

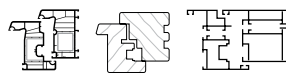

KOMFORT LINE **K-3**

Element connections



A reliable connection of the middle lock and extension lock or middle lock and stay arm with the help of the self-tapping screws – it excludes their disconnection or malfunction.

Miscro ventilation



Allows opening the sash for 6 mm to allow room ventilation without significant loss of warmth.

Pin of the top hinge bearing



When connected to the stay arm hinge it creates a very rigid fixture due to a special pin of the high-endurance polymer. This prevents self-disconnection.

Mushroom pins



Safety locking plates in combination with the mushroom pins of the corner transmissions and middle locks allows making a window that responds to basic security requirements.

Locking plate



Locking plates are produced of a special wear-resistant alloy (copper, aluminum, zinc). The wear at 20 thousand opening cycles does not exceed GOST 3077–2012 norms.

Safety locking plates



Safety locking plates provide for the difficulties for the break in.



HARDWARE FOR TIMBER WINDOW

Application range

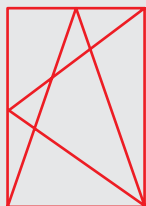

Width: 300–1520 mm
Height: 370–2390 mm

Tilt & turn sash

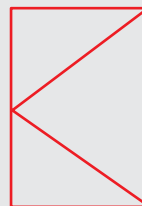

Width: 280–1280 mm
Height: 450–2390 mm

Turn sash

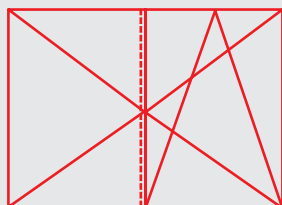

Width: 400–1280 mm
Height: 550–2390 mm

Double sash with the main
tilt & turn sash

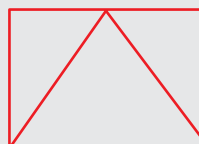

Width: 450–2000 mm
Height: 280–1600 mm

Tilt sash

Security

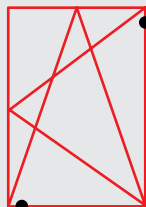

Basic
security



130 kg

Maximum
sash weight

Modern timber windows combine aesthetic properties of natural material, product durability, and high sound and heat insulation levels of a timber structure. For producing of such windows, it's used durable and wear-resistant window hardware.

New technologies allow equipping timber windows with accessories with wide range of functionality: an increased class of anti-burglary, reinforced hinges for heavy sashes, children's Security, micro slit ventilation and other advantages of modern window technologies.

The AXOR's assortment includes hardware for timber windows and doors based by the **Komfort Line K-3** line.



FOR THE FOLLOWING PROFILE SYSTEMS:

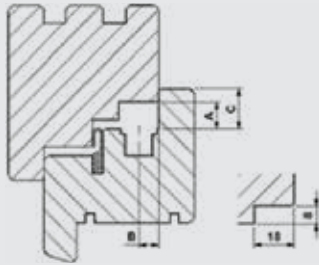

A	Airgap	12,0 +1mm
B	Groove axis	9,0 mm
C	Rebate width	18,0 mm

18/8-12/18-9

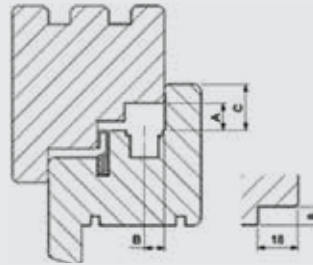

A	Airgap	12,0 +1mm
B	Groove axis	9,0 mm
C	Rebate width	20,0 mm

18/8-12/20-9

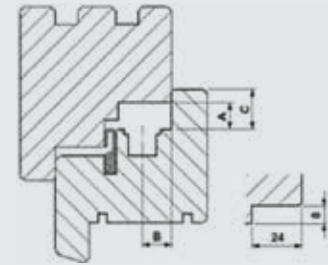

A	Airgap	12,0 +1mm
B	Groove axis	13,0 mm
C	Rebate width	18,0 mm

24/8-12/18-13

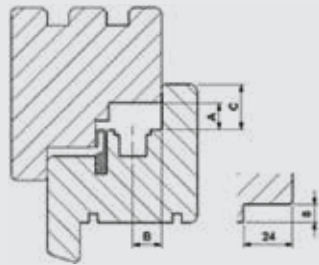

A	Airgap	12,0 +1mm
B	Groove axis	13,0 mm
C	Rebate width	20,0 mm

24/8-12/20-13

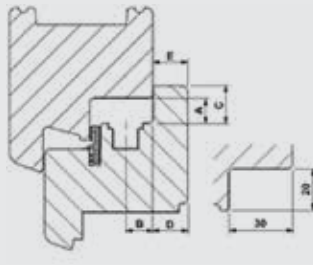

A	Airgap	12,0 +1mm
B	Groove axis	13,0 mm
C	Rebate width	18,0 mm

30/20-12/18-13

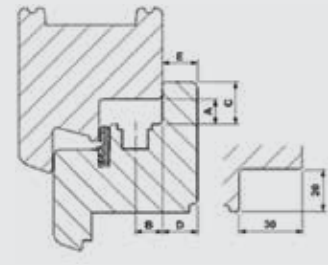

A	Airgap	12,0 +1mm
B	Groove axis	13,0 mm
C	Rebate width	20,0 mm

30/20-12/20-13



- 1** Locking plates
- 2** Burglar-resistant elements
- 3** Stay arm bearing
- 4** Corner bearing
- 5** Rebate corner hinge
- 6** Tilt locking plate





FUNCTIONALITY AND ENVIRONMENTAL FRIENDLINESS

Locking plates



1 Made of durable alloy ZAMAK, which guarantees trouble-free operation for 20 thousand opening cycles

Burglar-resistant elements



2 Anti-vandal plates in combination with mushroom cams allow equipping a window in accordance with requirements of basic security, which makes it difficult for intruders to break a window.

Stay arm bearing



3 Drill-in hinge ensures reliable sash fixation

Corner bearing



4 Designed for sashes with a maximum weight of 80 and up to 130 kg.

Rebate corner hinge



5 Provides smooth sash opening and tight gasket pressure. Adjustment ranges: +/- 2 mm (in height), +/- 1 mm (on the clamp).

Tilt locking plate



6 Ability to complete with a standard locking plate, and a special one for the system First Tilt

SMART LINE **S+**

Security and comfort in one solution

- SMART LINE S+ is a new hardware solution by AXOR INDUSTRY designed for the PVC and aluminum windows and doors of the inward opening.
- SMART LINE S+ standard configuration features wrong operation safety device, basic security solutions, microventilation mode and optimal number of the locking elements.
- Hardware features only mushroom pins which allows for several levels of burglar security of the window.
- Engineering solutions of SMART LINE S+ make this hardware reliable in use and easy in fast in mounting.
- Application range includes standard constructions such as turn, tilt, tilt/turn, first tilt and double sash.
- Reinforced hinge group provides for the system use with heavy sash with the weight up to 130kg.



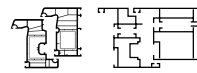

Application range

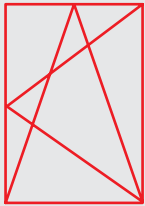

Width: 300–1520 mm
Height: 450–2390 mm

Tilt & turn sash



Width: 280–1280 mm
Height: 450–2390 mm

Turn sash

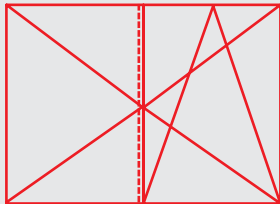

Width: 400–1280 mm
Height: 550–2390 mm

Double sash with the main
tilt & turn sash

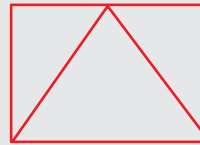

Width: 300–2390 mm
Height: 280–1620 mm

Tilt sash

Reliability



Certified
reliability



High
reliability



Tight fitting



Complex solutions
for the fast and easy
mounting



Smooth
operation



Silent
operation

Security

SMART LINE S+ provides a flexible burglar retardant system as it allows for the installation of various numbers of the anti-theft locking plates to fit the security requirements.

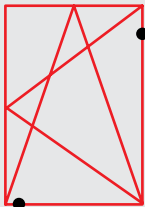

Basic
security

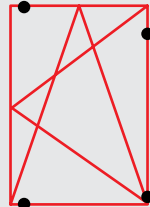

RC1 (WK1)

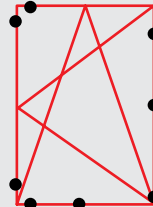

RC2 (WK2)

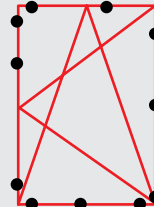

RC3 (WK3)



130 kg

Maximum
sash weight

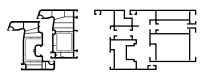

- Micro ventilation **1**
- Burglar retardant locking elements **2**
- Wrong operation safety device **3**
- Basic security level **4**

- 5** Step-by-step opening
- 6** Advanced security level
- 7** Decor overlay
- 8** Child security lock

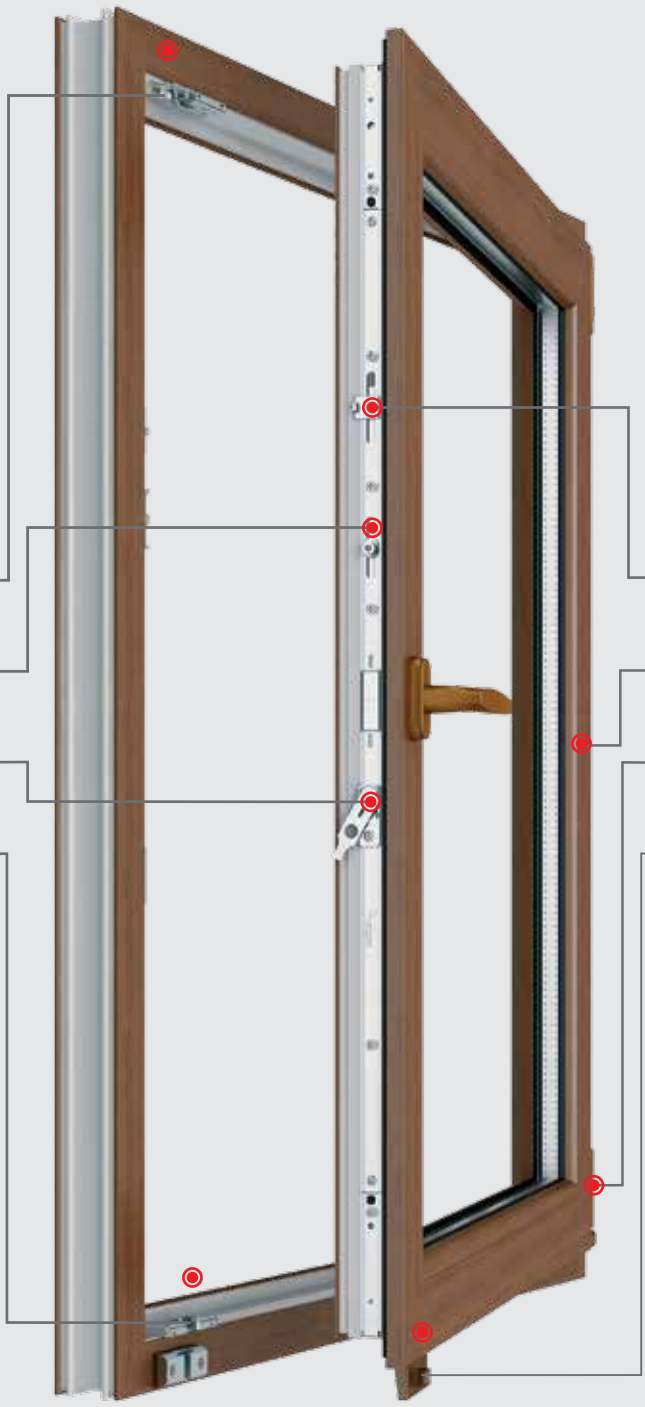

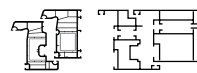

Standard configuration

Micro ventilation



Allows opening the sash for 6 mm to allow room ventilation without significant loss of warmth.

Additional options

Step-by-step opening



It allows controlling the level of the room ventilation. The range of the step-type opening varies from 12 to 20 mm.

Burglar - resistant locking pins



Provide for the difficulties in case of the break in which is an important feature for the private houses and for the apartments located at top or ground floors of a building.

Advanced security level



Hardware that features only mushroom pins allows for the significant increase of the security level via simply changing standard locking plates for the safety locking plates.

Wrong operation safety device

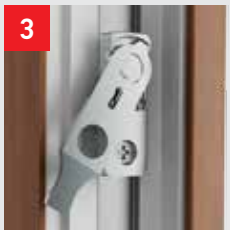

Does not allow the handle to be turned while the window is in an opened position which prevents false sash opening and provides for the smooth window operation.

Decor overlay



SMART LINE S+ hardware can be used with a variety of the window lamination options due to the assortment of the decor hinges overlay.

Basic security level



Standard configuration already includes two positions with the burglar retardant elements which increases break in properties of the window.

Child security lock



Special child security lock that blocks the window and allows only turning it to the ventilation mode.

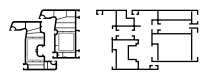

TECHNICAL FEATURES

Stay arm

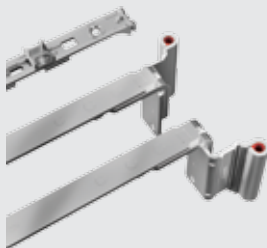

Use of the right-sided and left-sided stay arm with the increased to 20 mm integrated sash latch mechanism operating threshold.

Optimization of the operations' number

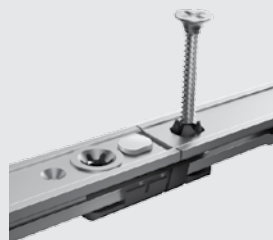

Straight cut excludes the necessity to shift the slider in the corner transmission and reliable element locking is provided with the help of the self-tapping screw.

Smart corner connection



Simple and reliable connection of the stay arm with the middle lock with the help of the special clamp which also makes mounting more comfortable.

Bottom hinge



Bearing pin of the bottom sash hinge (6x22 mm) is made of the high endurance steel and is integrated into the hinge housing which provides for the extra hinge strengths necessary for the use with the heavy sash.

Pin locking



Tilting of the bottom hinge bearing pin for 180° allows preventing the contact of the screwdriver bit lock with the pin bearing during the bottom self-tapping screw mounting.

Step-type angle locking



Step-type locking of pin bearing tilt angle prevents the shift of its position during the mounting process.

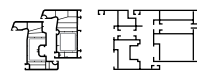

SMART LINE **S+**

Lock pins in the hardware housing



Lock pins in the hardware housing that allow fixing all the hardware elements before the self-tapping screws are engaged and thus exclude elements' shifting during the process.

Bush of the bottom hinge



The bottom hinge has a bush with the position lock pin made of the high endurance polymer. It prevents the adjustment screw from the unscrewing during the opening of the sash.

Pin of the top hinge bearing



When connected to the stay arm hinge it creates a very rigid fixture due to a special pin of the high-endurance polymer. This prevents self-disconnection.

Pin of the stay arm



The stay arm can be additionally complemented with the mushroom pin starting from the standard size of 600 mm.

Regulation of the bottom hinge



An option of regulating the pressure fitting of the bottom sash hinge in the range of $\pm 0,8$ mm.

Step-by-step ventilation



An option of installing step-type ventilation for the ready-made window.

KOMFORT LINE **K-3** SMART LINE **S+**

FIRST TILT **FT**

First tilting then open



First Tilt child safety system

First Tilt is a new-generation technology in which the regular sequence of opening a window has been changed as follows: when turning the handle into horizontal position, the window tilts into ventilation mode (**position 1**), and when the handle is turned vertically, the window opens completely (wide) (**position 2**). This system has a number of advantages in use vis-à-vis the regular PVC window.

That technology was designed especially for rooms, where it's necessary to provide some safety for children, given that it's more difficult for children to rotate a handle in the up position. Using special handle with key operated, it's possible to block down of sash's opening, leaving only the sash's tilting on airing available, that provides some additional security for children from accidents.

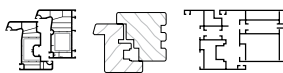

Application range

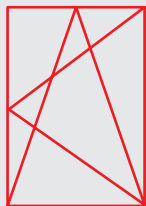

Width: 400 - 1520 mm
Height: 370 - 2390 mm

Tilt & turn sash

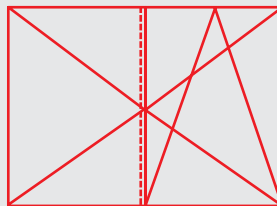

Width: 400 - 1280 mm
Height: 550 - 2390 mm

Double sash with the main tilt & turn sash

Handle with key

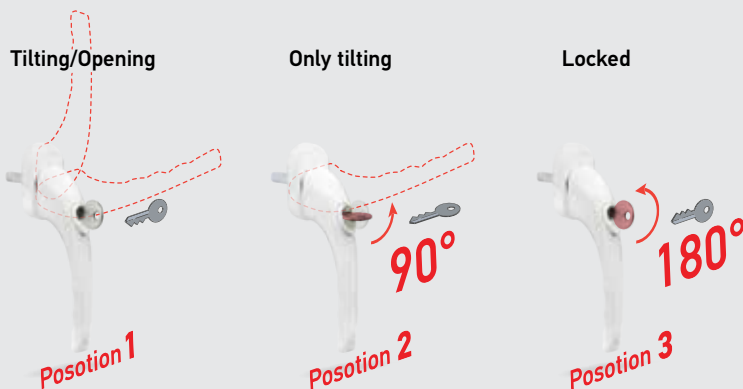

Security

Special window hardware parts (security pins and plates, and a handle with a key) can protect your home against inexperienced burglars and increase, as much as possible, the break-in time for professionals before the police arrive. The **AXOR First Tilt** system comes with two security points (pins and plates), and has an optional handle with a key.

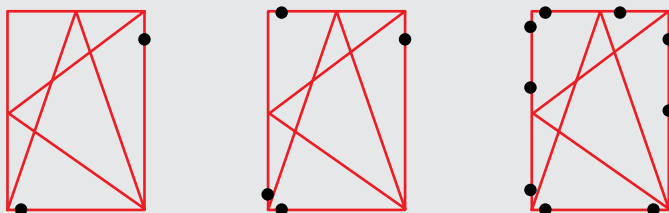

130 kg

Maximum sash weight

ELIT E+ CONCEALED HINGES SYSTEM

open new opportunities

- All elements of hidden hinges are integrated into the clearance (distance between a frame and rebate of window's sash - 24 mm design). Visually such hinges are invisible as indoors, and from the street. Such construct has a number of advantages: modern design of a window and additional functionality of a window construction.
- At present, there are options available to complete with concealed hinges group using hardware Komfort Line K-3 for timber and PVC windows. What allows producing translucent structures with different levels of anti-burglary.
- Hidden hinges make it possible to create some unique window design and combine it harmoniously with any interior. The absence of visible elements allows you to choose any color of window's lamination without reference to the shade of decorative covers.
- Through usage of concealed hinges it provides additional gasket pressure of a sash to a frame and great tightness of the window structure.



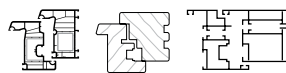

Application range

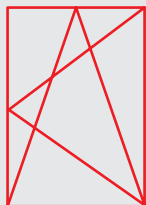

Width: 380 - 1520 mm
Height: 450 - 2390 mm

Tilt & turn sash

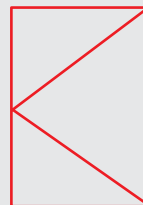

Width: 280 - 1520 mm
Height: 450 - 2390 mm

Turn sash

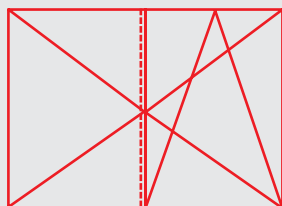

Width: 480 - 1280 mm
Height: 550 - 2390 mm

Double sash with the main
tilt & turn sash

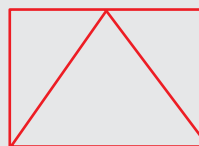

Width: 450 - 2000 mm
Height: 280 - 1600 mm

Tilt sash

Security

Due to the fact, that hidden hinges are “hidden” into profile’s system, it is extremely difficult for a burglar to reach any mechanism in hinges’ area. Anyway, together with other anti-burglar elements of a window, hidden hinges are able to protect a house from uninvited guests, including the RC2 burglary resistance class.

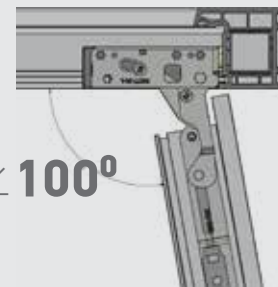

Maximum opening angle

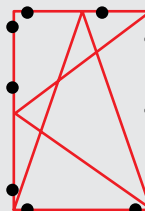
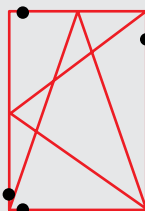
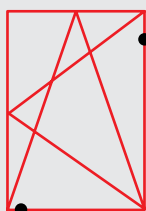

130 kg

Maximum sash weight

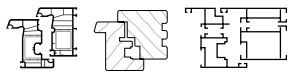

ADJUSTMENTS

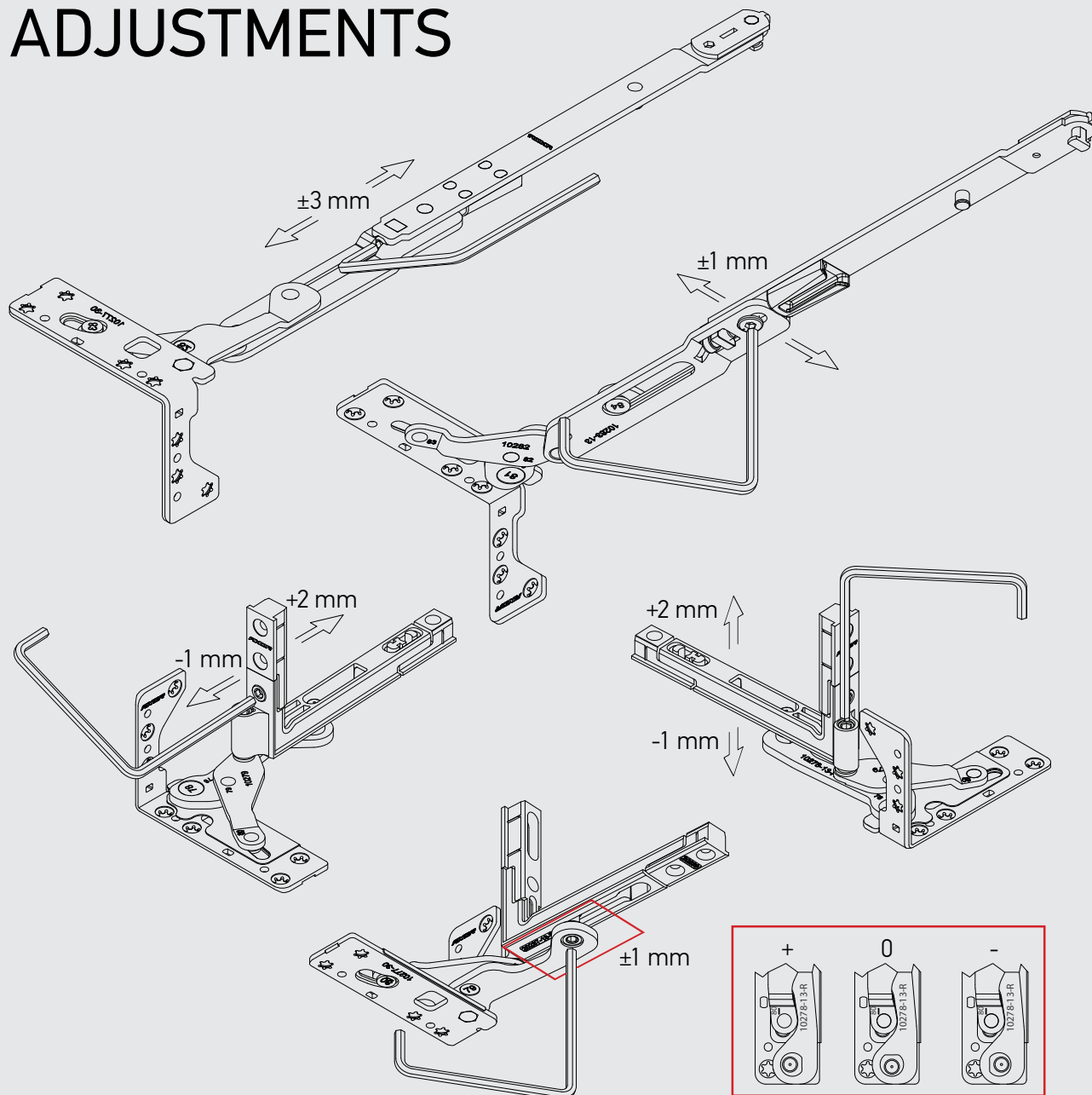



HARDWARE FOR ALUMINUM PROFILE

with fitting groove 16mm

Aluminum windows are a modern type of window systems that is gaining more and more popularity among various categories of buyers. This trend is due to the unique properties of the material from which they are made.

Indeed, the **benefits of aluminum** are hard to overestimate. First of all, it is high strength and resistance to external factors and accordingly longer service life.

In addition, aluminum window systems are **environmentally friendly**, because aluminum does not contain heavy metals and does not emit harmful substances under influence of ultraviolet radiation.

High toughness and at the same time minimal material weight make them easy to install and **extremely resistant** to deformation and the wear and tear during operation.

Aluminum profile is ideally suited for the implementation of design decisions during producing of windows of **non-standard shapes and sizes**. And finally, aluminum windows harmoniously fit into the **design** of both new buildings made in a modern style and old buildings, in particular, due to the possibility of painting.

However, it should be remembered that only **high-quality window hardware** is the key to quality of complete window system. **AXOR's assortment** has been replenished with hardware for aluminum profiles with fitting groove 16 mm.

Maximum sash weight



130 kg

With concealed hinges



80 kg

With visible hinges

Available with the following lines:

KOMFORT LINE K-3

SMART LINE S+

FIRST TILT FT

ELIT E+



DOOR LINE **DL**

Door locks

AXOR INDUSTRY presents product line – door locks. Like all AXOR products, door locks are characterized by:

- reliability and durability in the operation of all the elements;
- the strength of high-quality materials, of which all the components are made;
- unique protective surface coating that ensures high resistance to corrosion.

Closed, all-steel case of AXOR Door Line DL locks creates a finished aesthetic look of design and ensures all its components protection against ingress of dust and debris into the mechanism.

Door Line DL product range includes multi-point mortise locks, short one-point locks and locks for bathroom doors.

Advantages of the AXOR door locks

- Easy changing of the door swing direction;
- Door casing extension;
- The possibility of using push handle sets with 3 screw holes;
- Individual branding;
- Security pins;
- Deadbolt with steel pins.



PRODUCT BRANDING

By choosing the TM AXOR hardware manufacturer of PVC windows and doors obtains an option of branding the ready product by application of their logo on the gear box. Gear box was specially designed for the TM AXOR hardware and is located accurately near the handle which provides for the constant visual contact with the manufacturer's logo when the window is in open/tilt position.



Cover for gear:

- Advertisement for the manufacturer brand;
- Easy and reliable mounting;
- Application and dispensing of any information required by the partner company.

Advantages of the logo on the cover:

- It adds to the customization of the product;
- Provides for making the manufacturer's brand more popular and serves as a specific guaranty of quality.
- Serves as a long-term and unique advertisement of the manufacturer's brand.

AXOR INDUSTRY offers two types of branded coatings to manufacturers of PVC windows:

PVC cover:

- produced from the high-quality PVC with the high-grade operational features, deformation, humidity, high and low temperature resistant;
- easily mounted with the hardware, zero accidental dismounting;
- allows a possibility of the cover color choice, application of the full-color logo or contact information.

ZAMAK cover:

- made of the high quality zinc-aluminum alloy;
- is not affected by the external aggressive factors;
- all details and sketches of the product are included to the form initially and the cover is molded with the logo;
- ZAMAK overlay provides for the premium-class logo look which serves to create a reputation of the reliable manufacturer of the high-quality products.

OUR WORLD OF AXOR

AXOR Start-UP. Special options for our partners.

Our collaboration with PVC windows and doors manufacturers is not limited with hardware sales as we also provide for the full-cycle before- and after-sale maintenance services.

At the beginning of our collaboration the essential actions from our side are represented by the technical audit of the production quarters, 2 day coaching of the employees a tour partner's location, provision of the mounting equipment (drilling jigs, adjusting tools, punching machines), software, full set of the informational-technical materials (catalogs, mounting layouts etc) as well as required first-line technical support.



Technical support

Production and mounting of windows and doors inevitably produce technical questions. Despite the variety of the reasons for their occurrence our technical support service is ready to reply for the request about hardware and ready product mounting in 24 hours after the request was received.



Logistics

AXOR INDUSTRY organized its logistics in a way to be able to process and deliver orders as soon as possible and within the scheduled time-frame. For this reason we have a developed network of the regional warehouses and logistic routes are developed in a way to offer the client the most appropriate way of delivery. We also effectively use express delivery method including delivery in small batches.



Software customization

To obtain a standardized data exchange and increase service quality our experts render assistance in entering all the necessary data about TM AXOR products to the client's software. This provides for the possibility to decrease administrative expense and time which is necessary for the software customization.



On-line order management service

AXOR INDUSTRY provides for own clients some secure access to online service of order management, which covers and tracks all sales' stages. Convenient interface allows to have complete information for clients about status of their orders, product's price, bills and orders' statistics, and also to be informed regarding to some relevant company's special offers.



Media-center

To enable our clients obtaining up-to-date information we created media-center which is available 24 hours per day at www.axorindustry.com. This electronic service gives access to brochures, technical catalogues, mounting layouts, video materials and presentations.



Marketing support

We developed a complex program of the marketing customer support. Marketing materials are focused on the advantages of the windows with our hardware. We render assistance for conducting advertisement campaigns, sales outlets design, personnel qualification upgrade via coaching seminars and training sessions.

CERTIFICATES



Certificate ift Rosenheim



Certificate ISO 9001:2015



Certificate DSTU



Certificate GOST



Warranty certificate



Brand of the Year



[instagram.com/axor_live](https://www.instagram.com/axor_live)



[facebook.com/AxorIndustry](https://www.facebook.com/AxorIndustry)



infoaxor@axorindustry.com



+38 067 55-42-777



+38 (067) 500-77-79

+38 (056) 794-0-766

+7 (985) 700-09-44

